

Item	Data	
Air End model	ATL-30A	
Working pressure PSI	44	58
Motor speed(RPM)	3550	3550
Air flow (cfm)	205	194
Motor Power (KW)	22	22

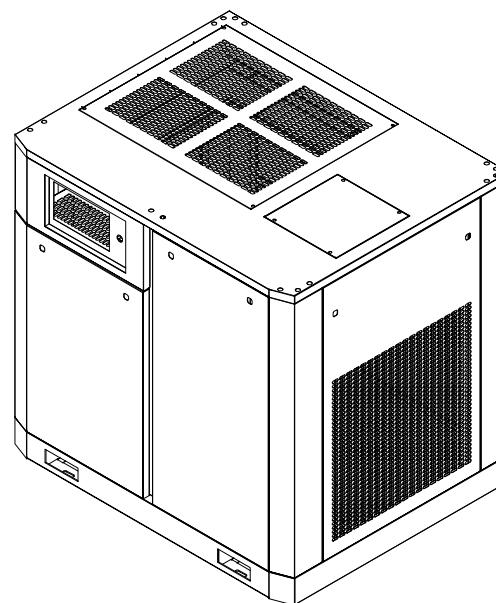

FECHA : 20/7/2020				
ACOTACIONES : MM				

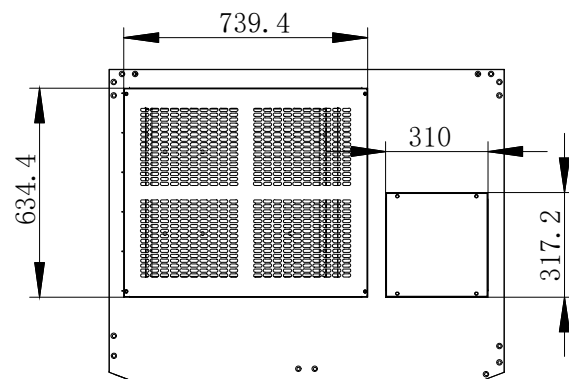